

# VC 攝像機、VC-HDTX及VC-AC08連接說明

1. 將攝像機鎖固於拖盤上

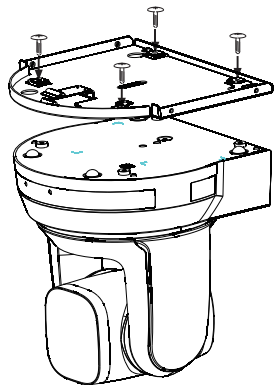

2. 將連接線接至攝像機 I/O Port

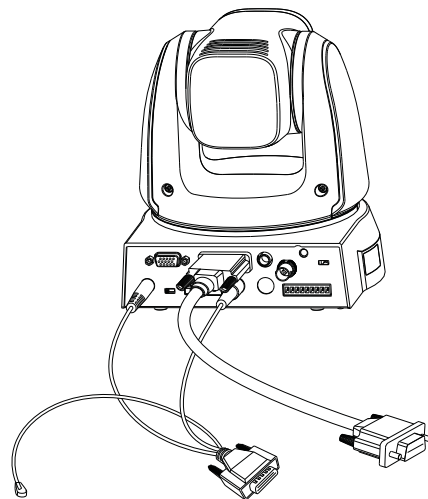

3. 將 VC-AC08 底座鎖固於牆面上

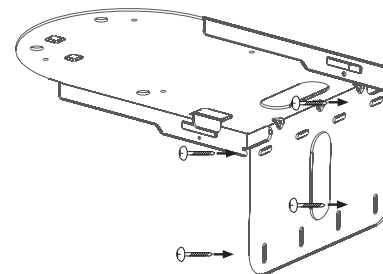

4. 將攝像機置入底座並鎖固

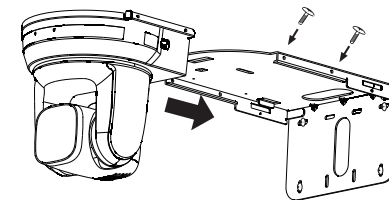

5. 整理線材穿過 VC-AC08 上方開孔，連接至 VC-HDTX

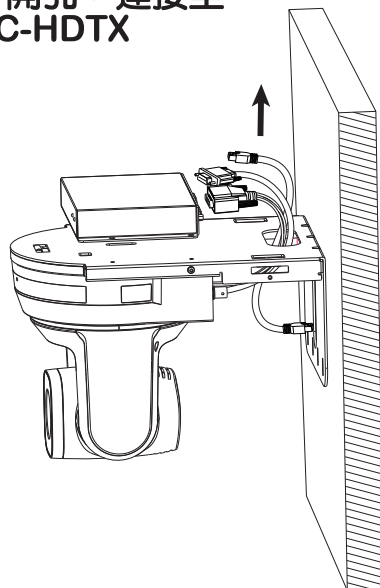

6. 鎖固 VC-HDTX

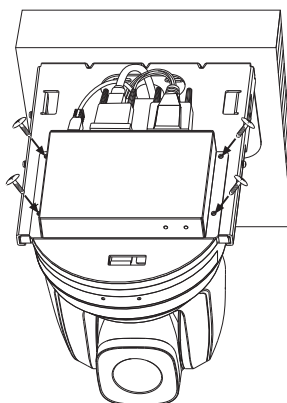

7. 整理線材，扣上板金蓋

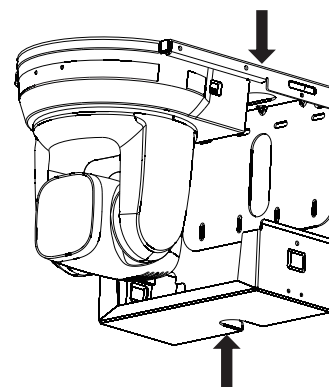

8. 鎖固兩側螺絲，固定板金蓋

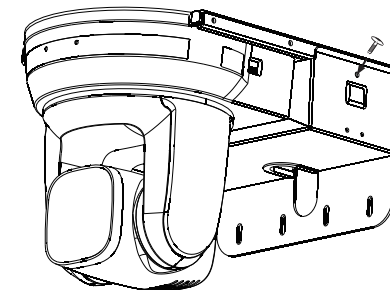

[說明] 攝像機可依需求正裝或倒裝，本範例僅以倒裝方式做說明